

Article number: 12857000040840  
Description: KLEE-coil 857 000 040.840  
M4 Brass

## Measures

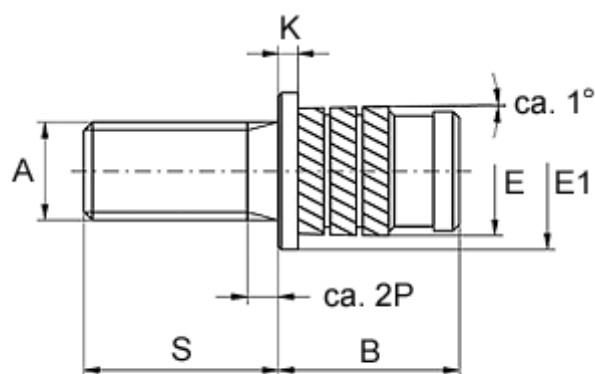

Gevindlængde =  $S - 2P$   
P = stigning

Flange diameter E1	= 7.2
Flange height	= 0.8
Male thread A	= M4x0,7
Min distance to edge	= 2.5
Mounting length B	= 7.4
Outer diameter E	= 5.80
Pin length S	= 10
Recommended bore diameter	= 5.4